

Versuchsboot S-Kanamono 1944

Außenschiff

Blatt

1/2

Maßstab 1/100

© J. Barche 2005

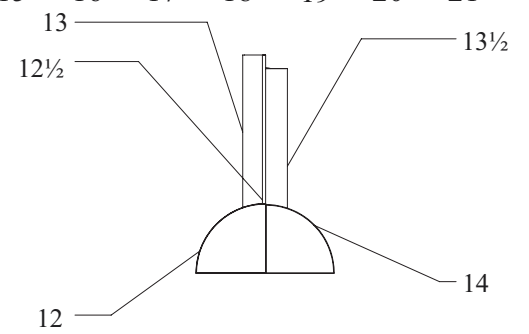
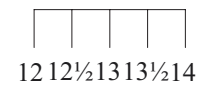
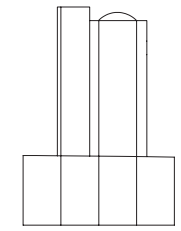
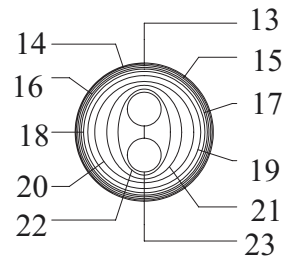
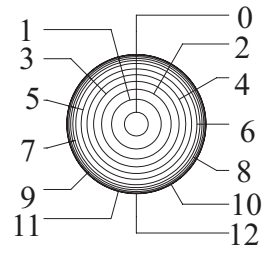
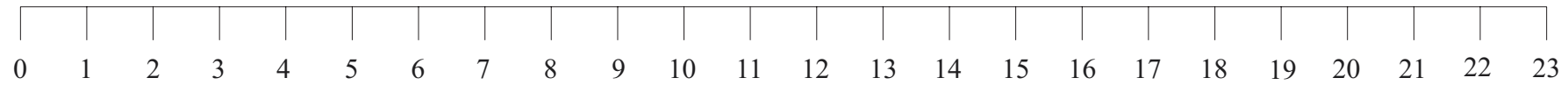
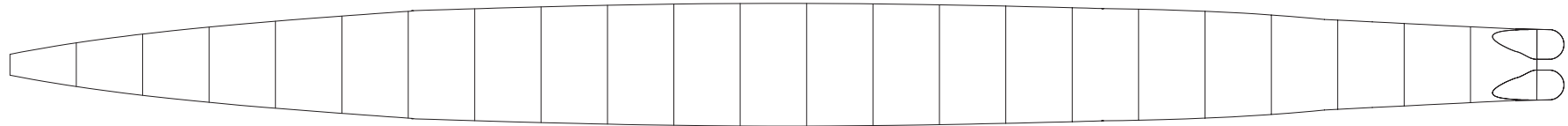

Versuchsboot S-Kanamono 1944

Spantenriss

Blatt

1/2

Maßstab 1/100

© J. Barche 2005

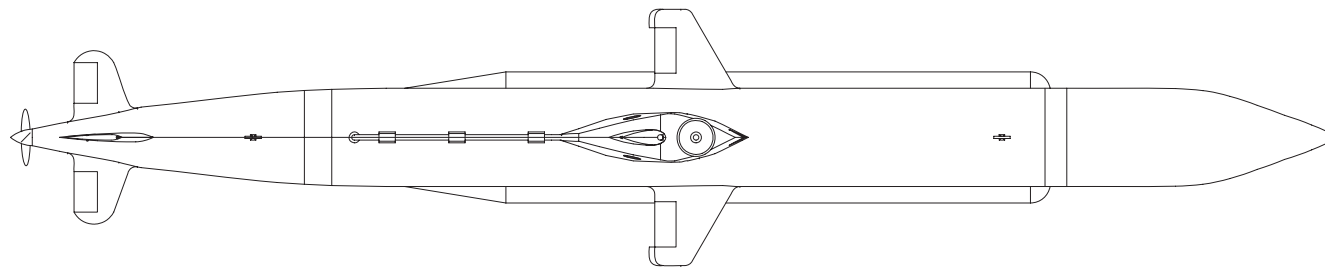
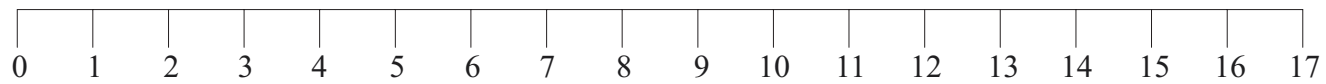
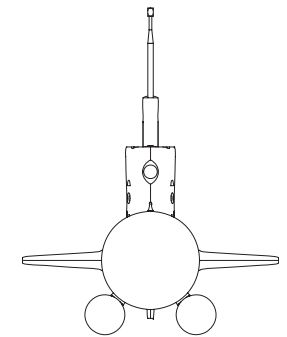
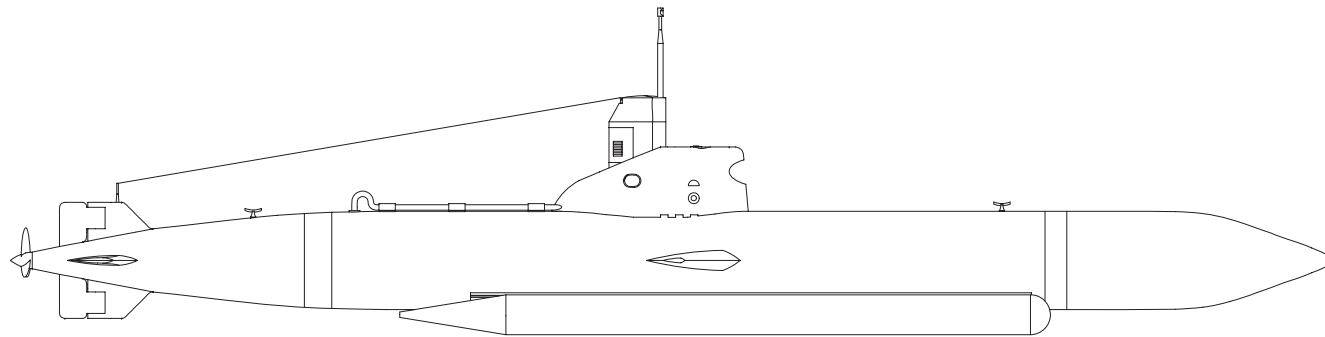
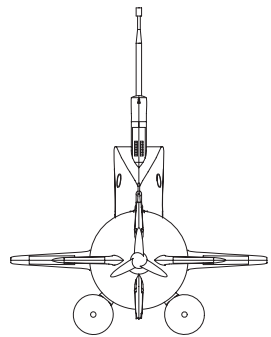

Ohne Torpedos

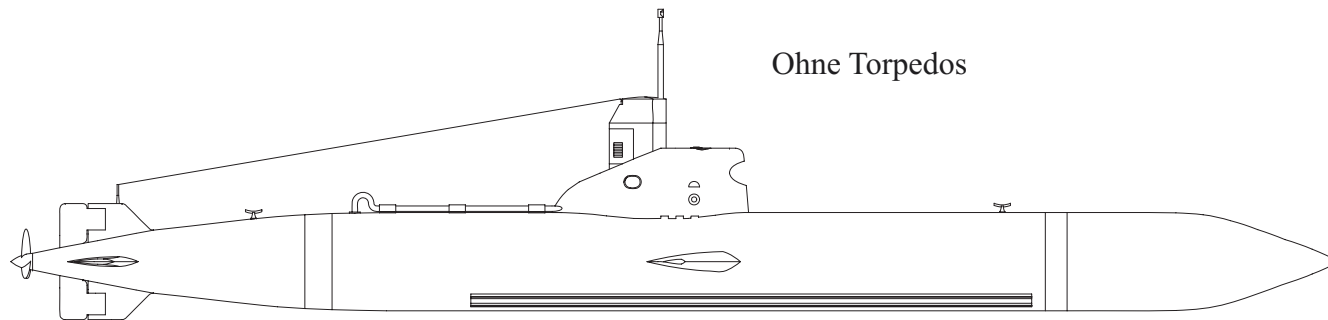

Kairyu Frühe Version
1944/45

Außenschiff

Blatt

1/5

Maßstab 1/100

© J. Barche 2005

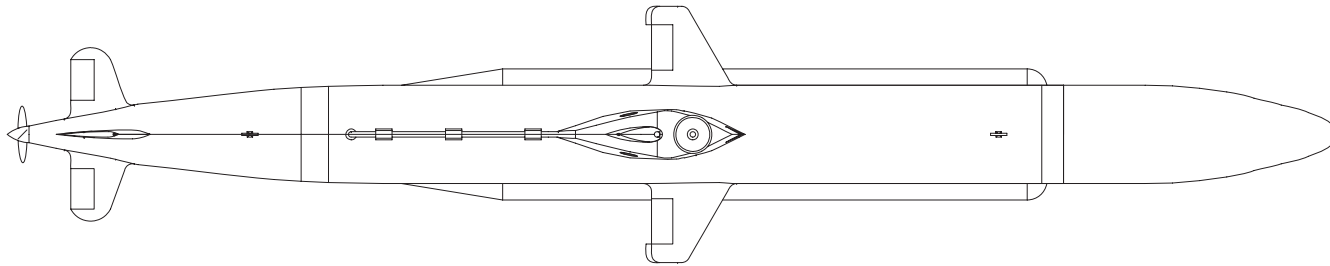
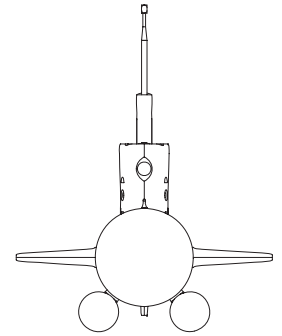
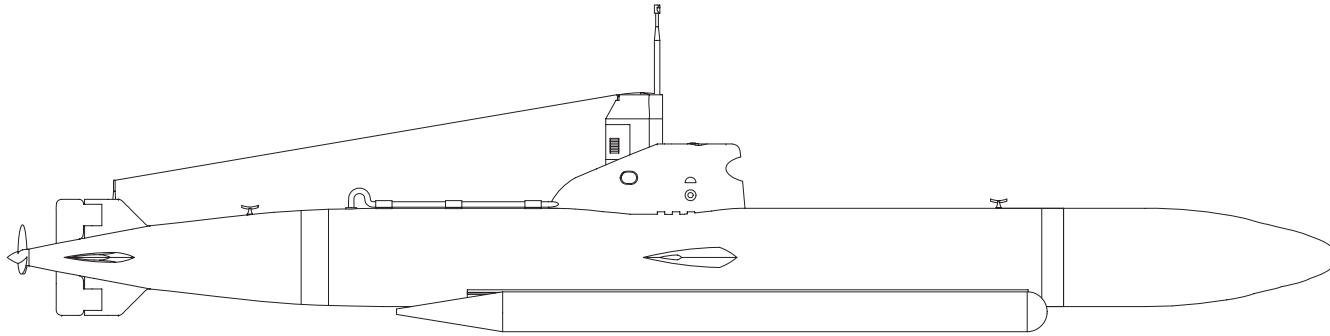
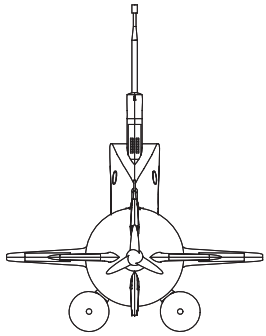

Ohne Torpedos

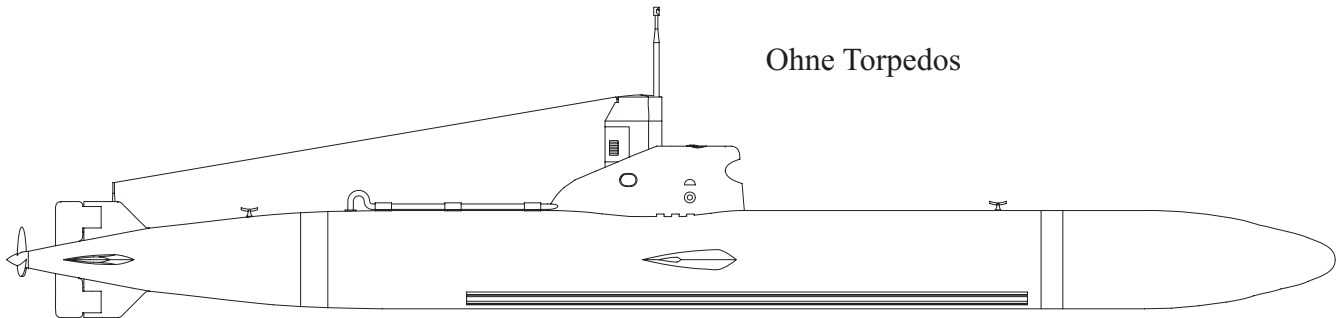

Kairyu Spätere Version 1944/45

Außenschiff

Blatt

2/5

Maßstab 1/100

© J. Barche 2005

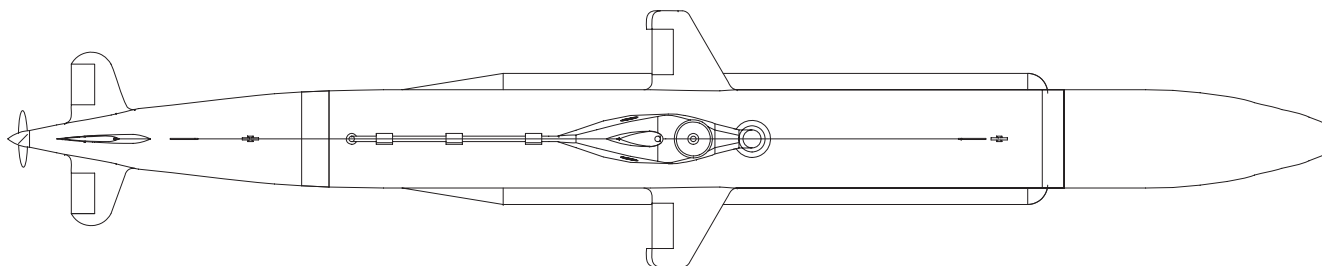
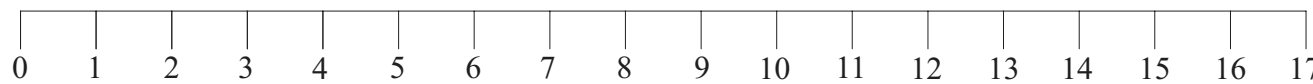
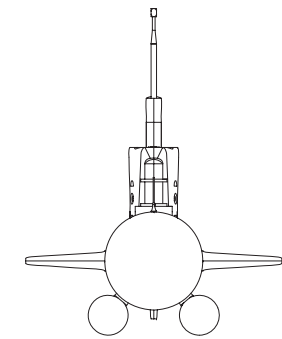
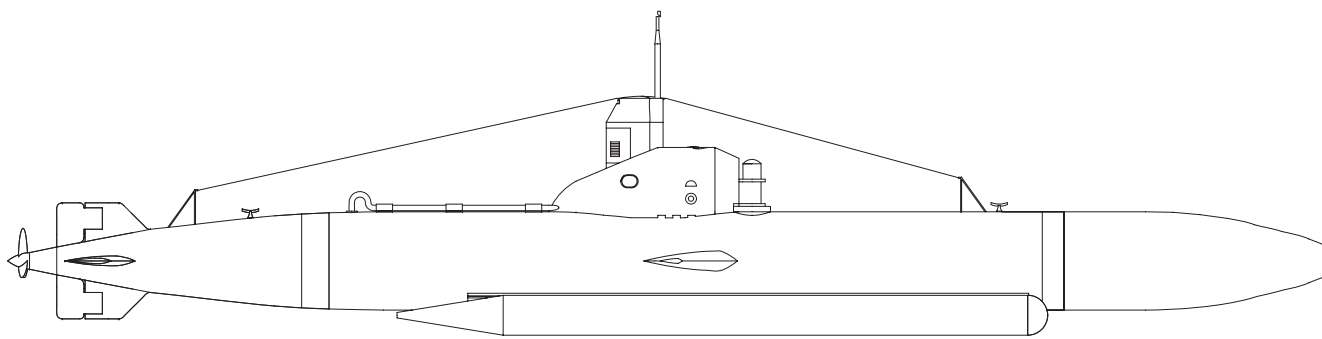
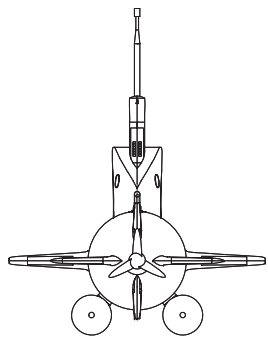

Ohne Torpedos

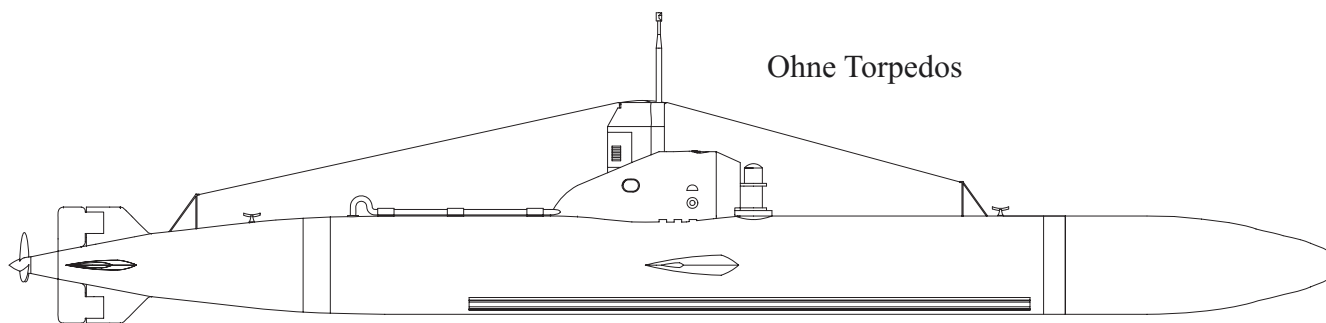

Kairyu Spätere Version mit
geändertem Turm 1945

Außenschiff

Blatt

3/5

Maßstab 1/100

© J. Barche 2005

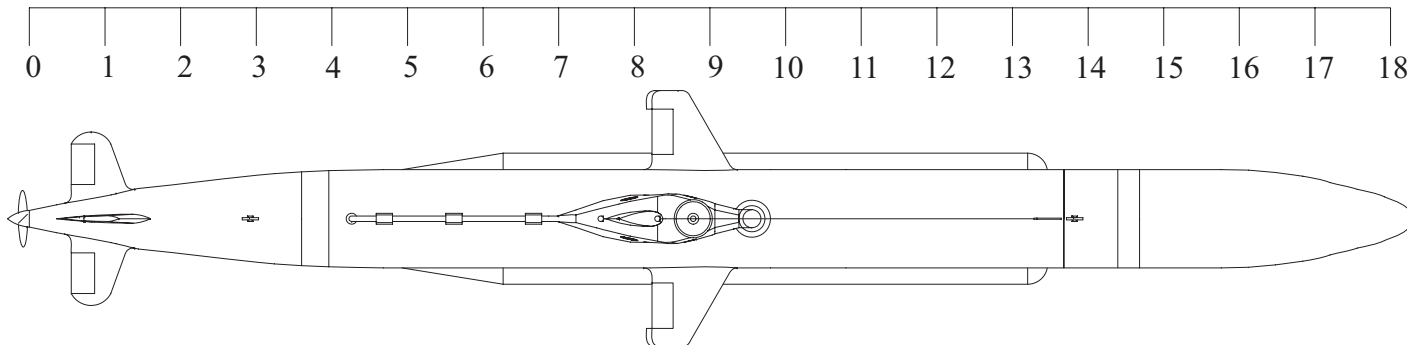
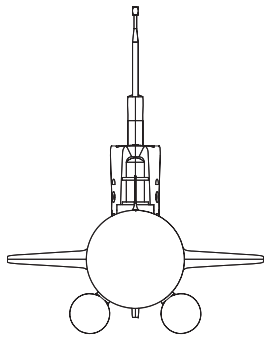
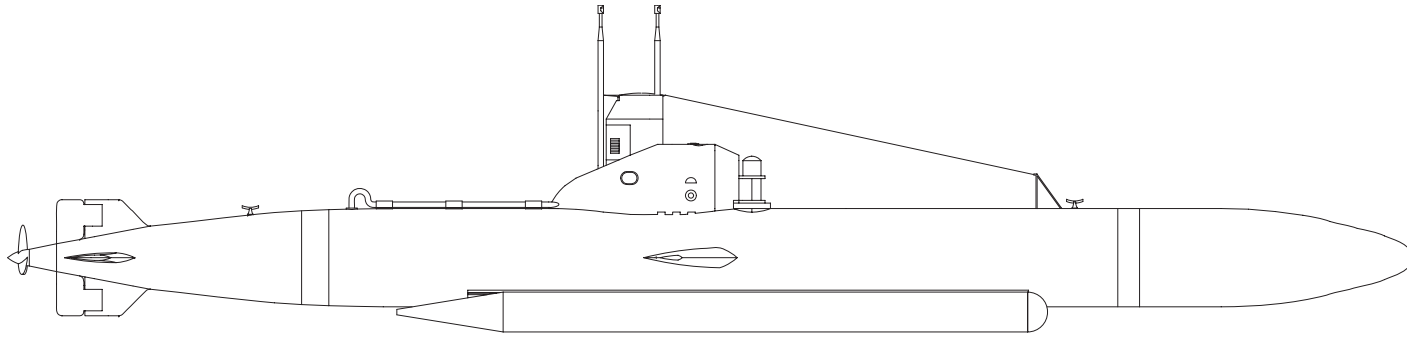
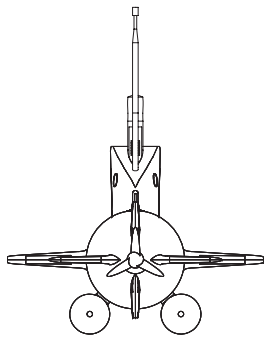

Ohne Torpedos

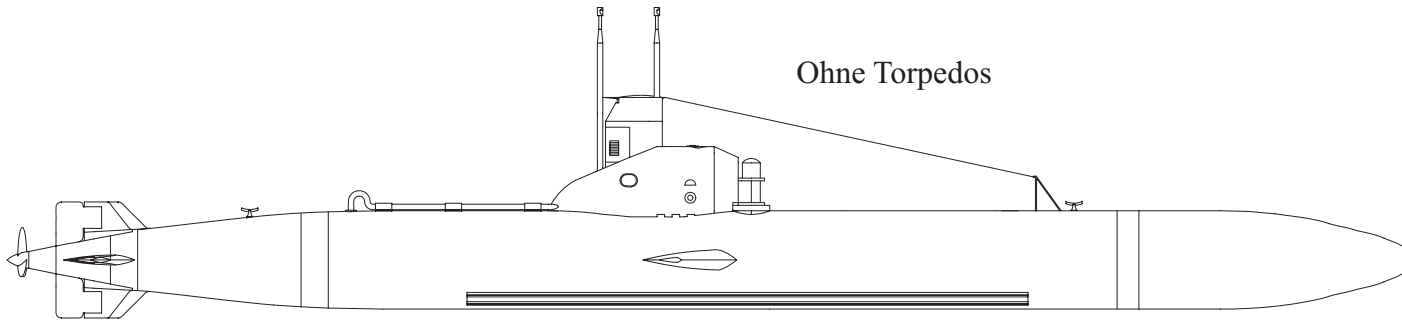

Kairyu Trainingsboot 1945

Außenschiff

Blatt

4/5

Maßstab 1/100

© J. Barche 2005

Frühe Version

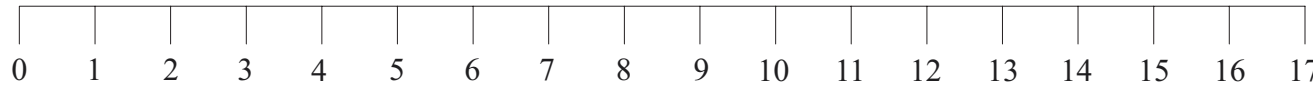
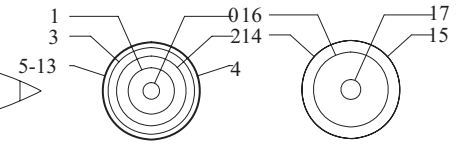

Späte Version

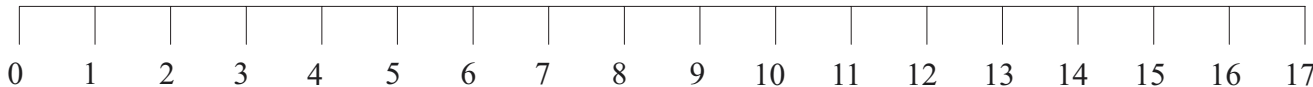
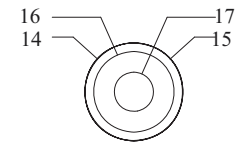

Trainer

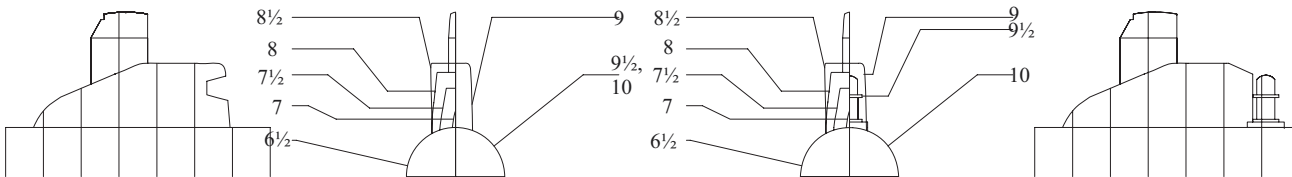
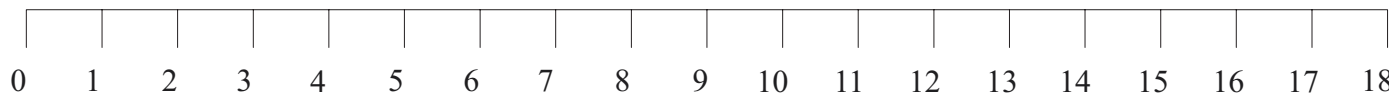
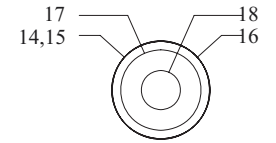
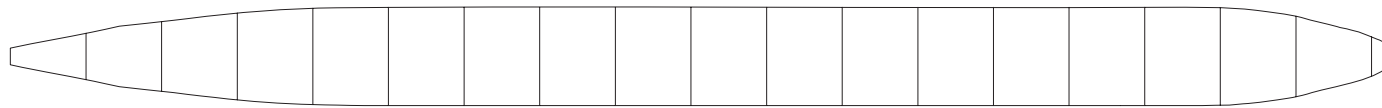

Turmversionen

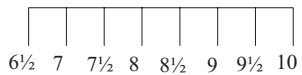

Kairyu
1944/45

Spantenrisse

Blatt

5/5

Maßstab 1/100

© J. Barche 2005