

Ko Hyoteki Typ B 1943

Außenschiff

Blatt

1/2

Maßstab 1/100

© J. Barche 2005

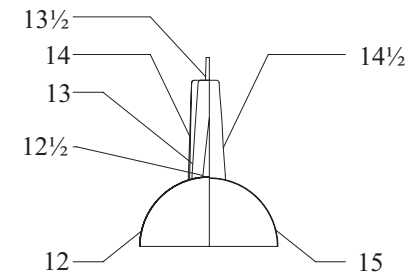
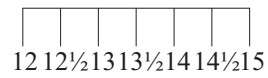
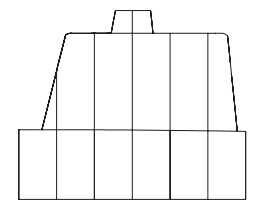
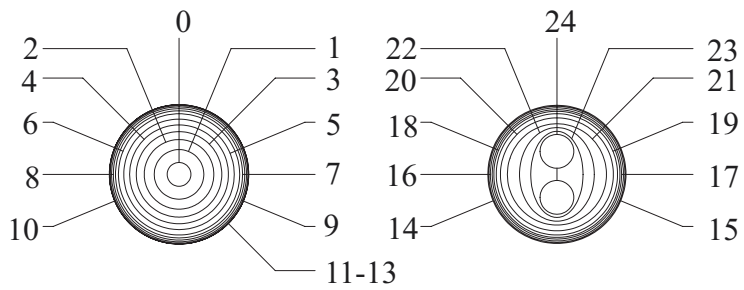
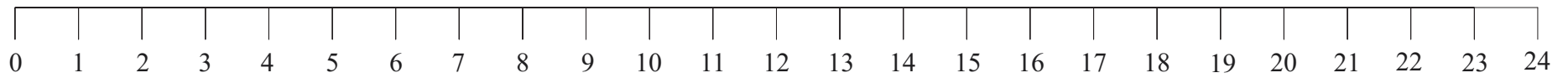
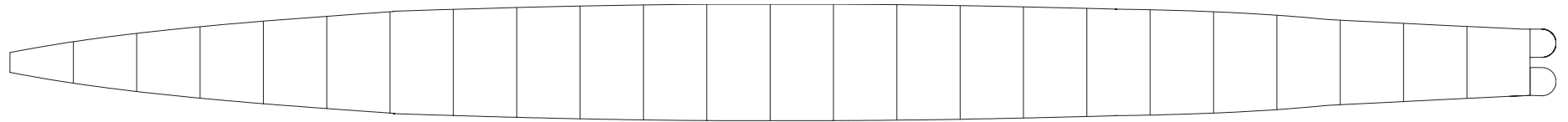

Ko Hyoteki Typ B 1943

Spantenrisse

Blatt

2/2

Maßstab 1/100

© J. Barche 2005

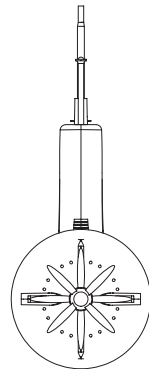
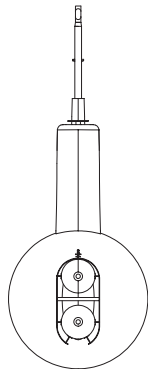
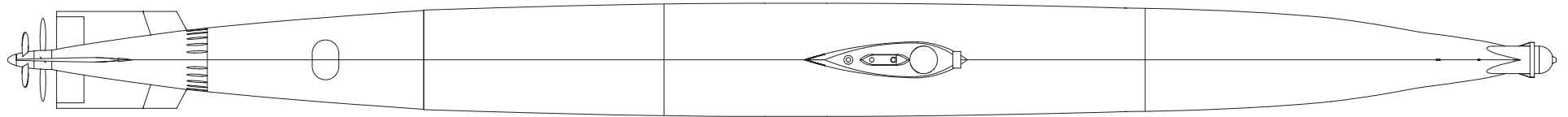
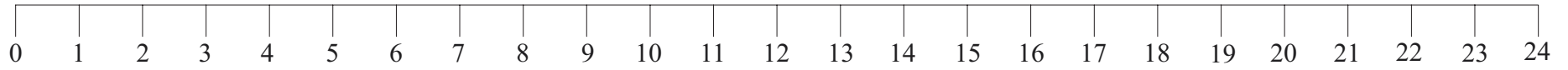
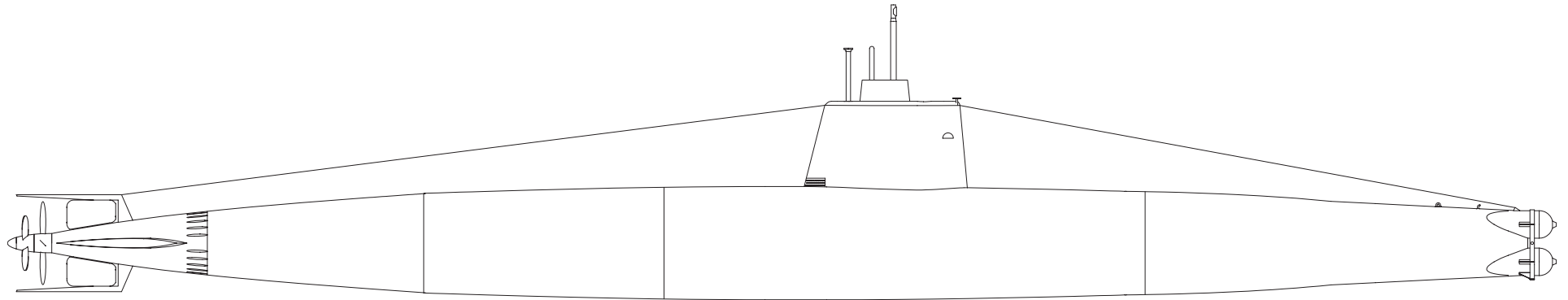

Ko Hyoteki Typ C 1943-1945

Außenschiff

Blatt

1/4

Maßstab 1/100

© J. Barche 2005

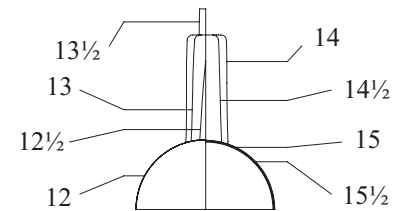
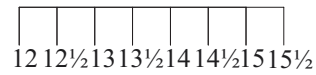
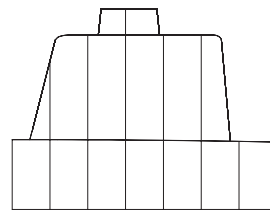
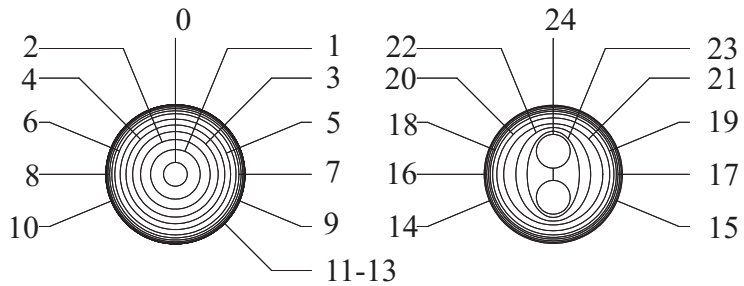
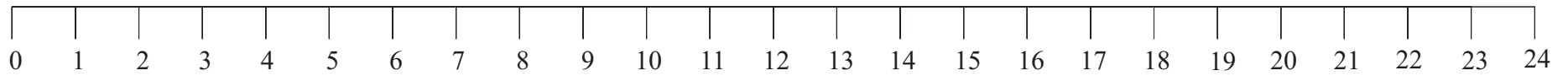
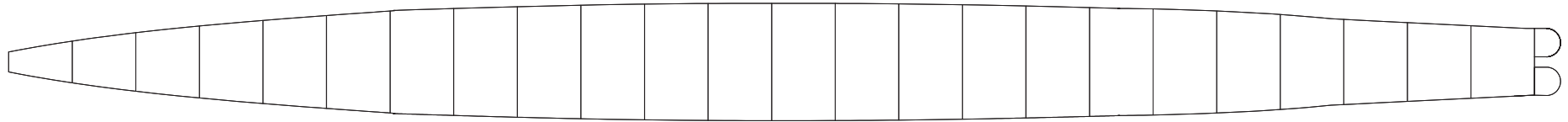

Ko Hyoteki Typ C 1943-1945

Spantenrisse

Blatt

2/4

Maßstab 1/100

© J. Barche 2005

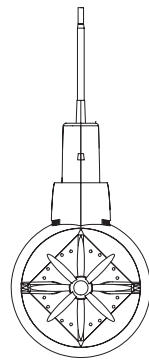
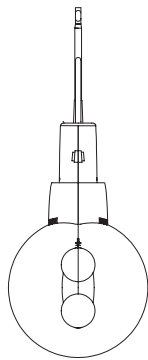
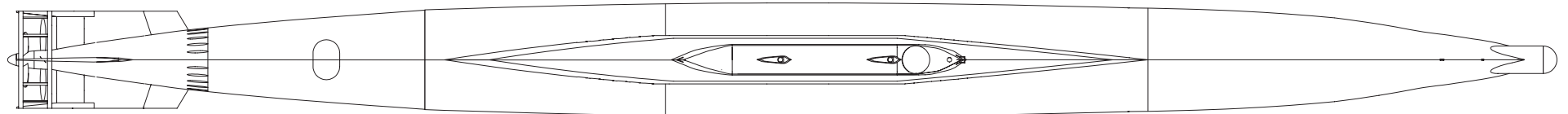
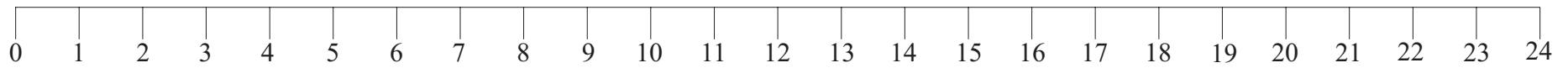
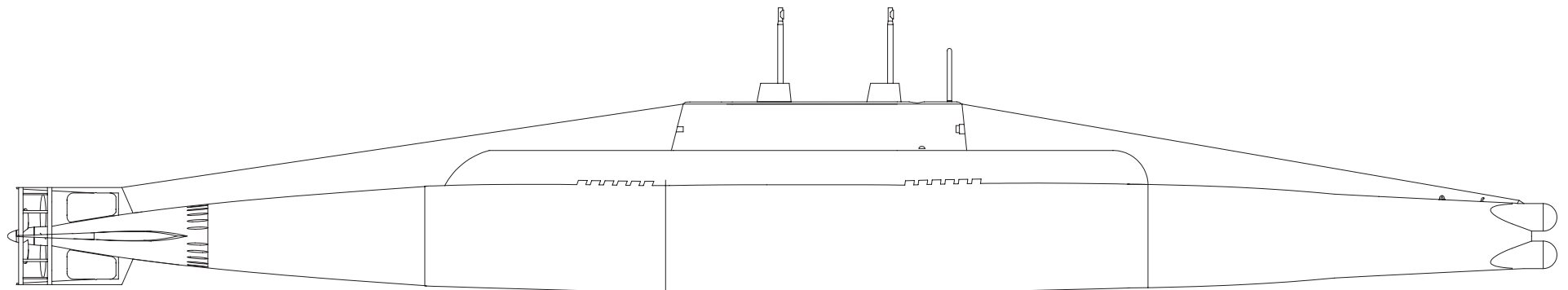

Ko Hyoteki Typ C 1943-1945

Trainingsboot
Außenschiff

Blatt

3/4

Maßstab 1/100

© J. Barche 2005

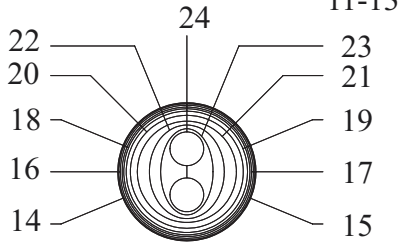
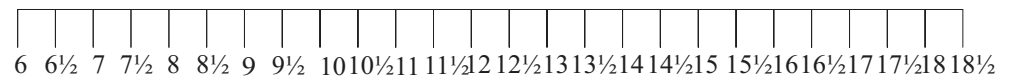
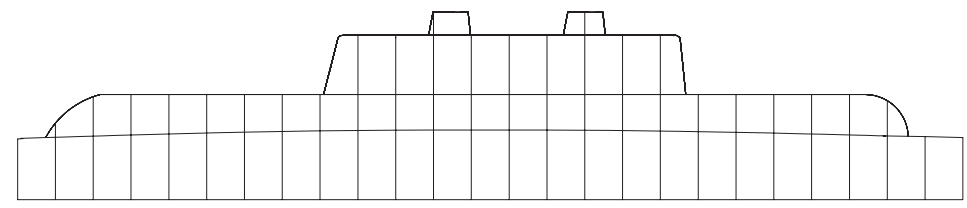
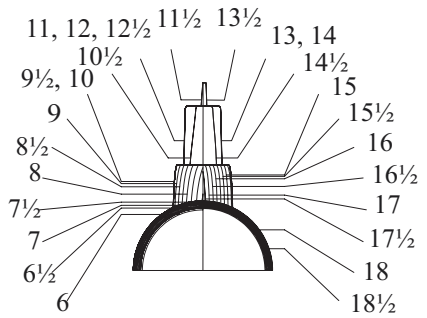
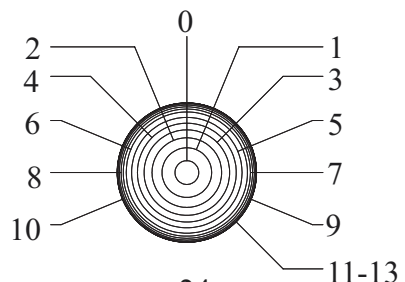
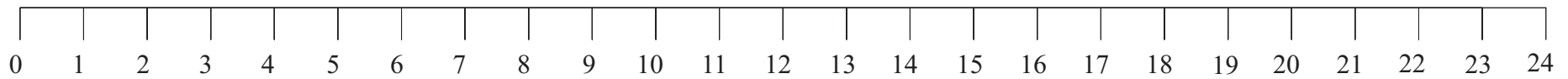
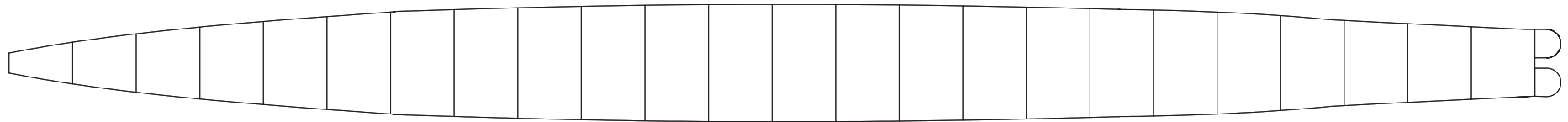

<h2>Ko Hyoteki Typ C</h2> <h3>1943-1945</h3>	
<h3>Trainingsboot</h3> <h3>Spantenrisse</h3>	Blatt 4/4
Maßstab 1/100	© J. Barche 2005